

Ameron Traditional Series Poles

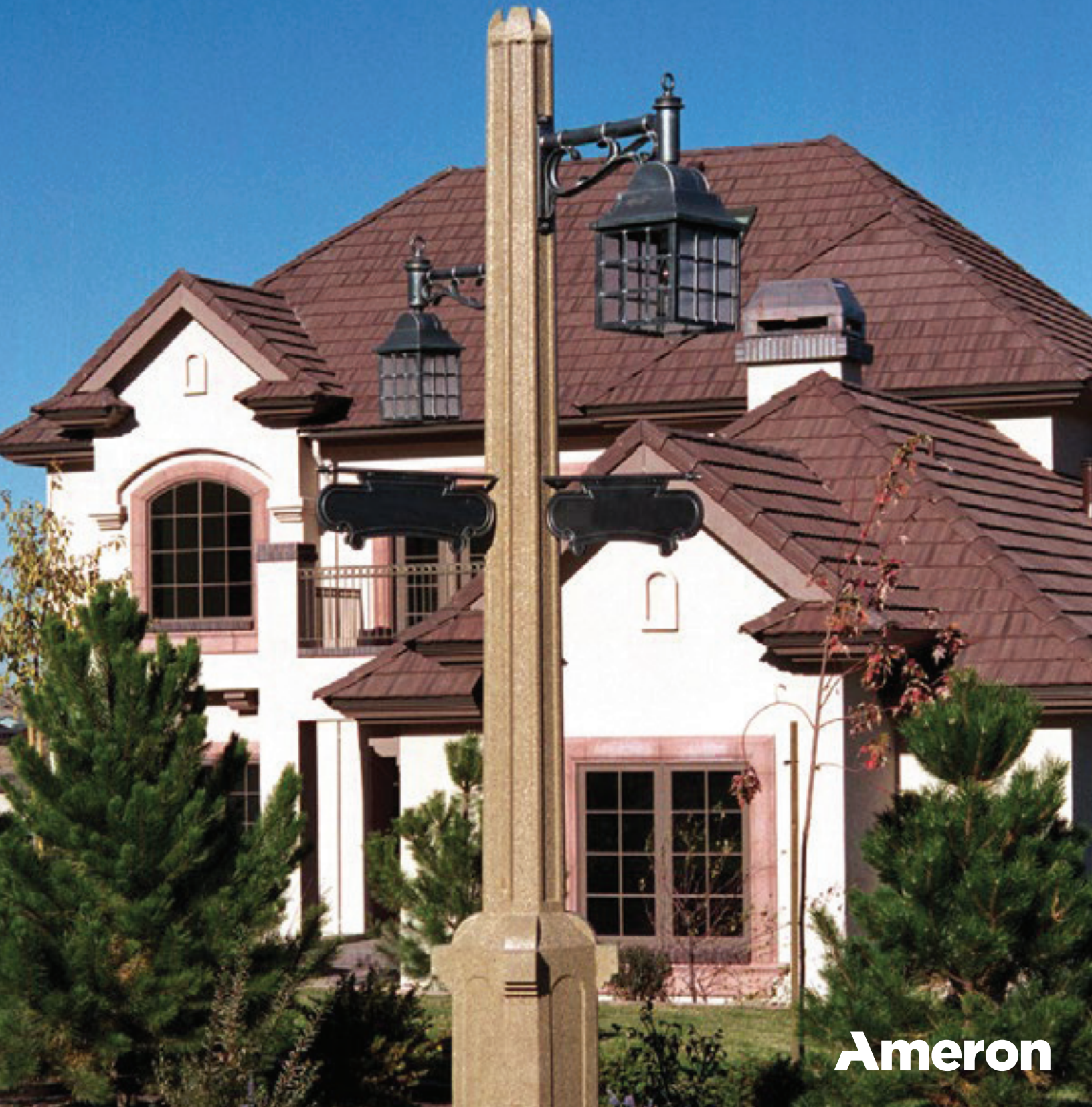

Ameron





From **industrial** to **municipal**, we have the right pole for your project.

Table of Contents

Aegean Poles	4
Corsican Poles	6
Delphi Poles	8
Goleta Poles	10
Huntington Poles	12
Kodiak Poles	14
Monterrey Poles.....	16
Olympian Poles	18
Washington Poles	20
Washington Poles - Embedded	22
Tall Washington Poles.....	24

Ameron

Traditional Series

Aegean Poles

Available in base plate and internal bolting

The Aegean pole reflects ancient Greek influence at its best. It features classic detailing including an annulated base, fluted shaft with unique entasis taper, and flared collar. This time-honored design enhances modern surroundings.

Our Ameron Traditional Series lighting poles combine the charm of yesterday with the technology of today. Available in a wide variety of styles, colors, and finishes, these poles provide architects and designers with many creative options.

Features and Benefits

- Prestressed steel and highest quality concrete are centrifugally cast for ultimate strength and durability
- Natural stone and terrazzo aggregates maintain a like-new appearance with virtually no maintenance
- Conforms to applicable sections of ACI, AASHTO, ASTM, and IBC standards
- Exclusive 10-year warranty

Colors and Finishes

A wide range of standard, preformulated, and custom colors are available. The concrete shafts are lightly blasted to expose the texture and color of the natural stone. See separate aggregates and finishes sheet for details. We offer Amerishield, a premium graffiti-resistant coating, as well as other durable sealers and protectants that further enhance colors, protect the concrete surface, and aid in the removal of graffiti.

We offer Amerishield, a premium graffiti-resistant coating, as well as other

Durability with a classic touch

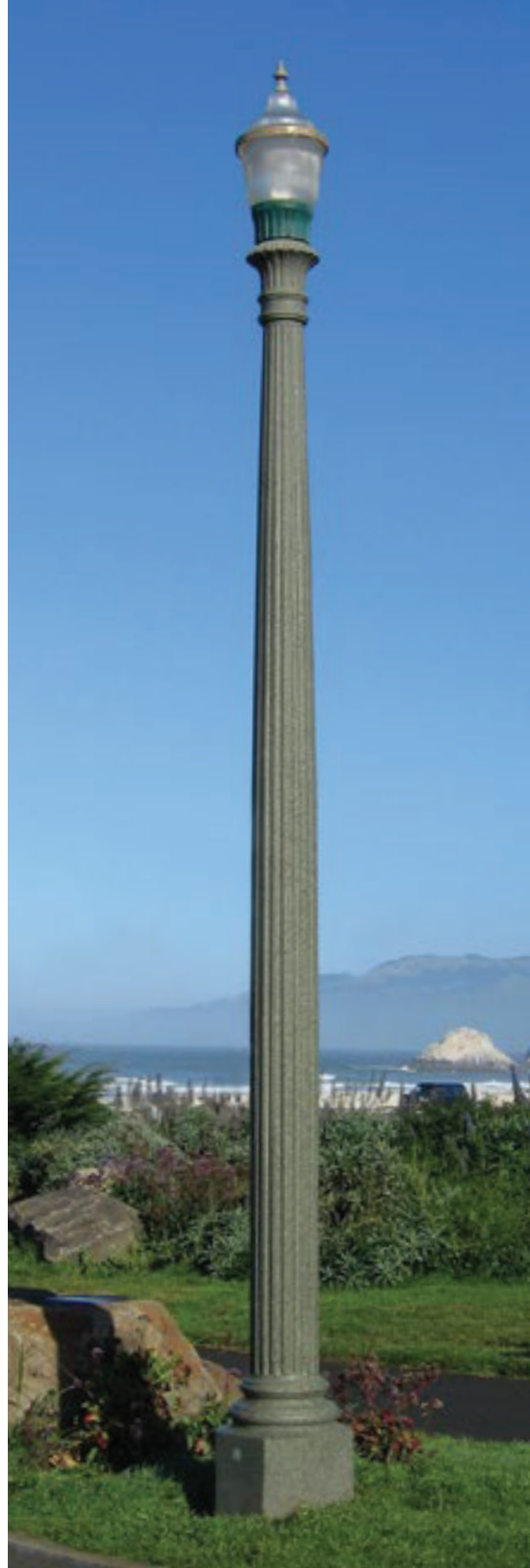



Base plate style - Information

Catalog number	Pole height "A"	Base OD	Anchor bolt	Bolt circle	Base plate (Sq)	Ultimate GL moment (ft/lb)	Pole weight (lb)
21CT13	13' 6"	17½"	¾" × 18" × 4"	22"	18½"	23,200	850
21CT15	15' 6"	17½"	¾" × 18" × 4"	22"	18½"	23,200	1,100

Internal bolting base plate style - Information

Catalog number	Pole height "A"	Base OD	Anchor bolt	Bolt circle	Base plate (Sq)	Ultimate GL moment (ft/lb)	Pole weight (lb)
21ST13	13' 6"	17½"	1" ∅ A449	6½"	N/A	20,400	850
21ST15	15' 6"	17½"	1" ∅ A449	6½"	N/A	20,400	1,100

*Internal adapter plates are available for smaller and larger bolt circles. Contact NOV representative for alternate bolt sizes and patterns.

Specifications: Use Contemporary specifications.

Colors and finishes: See Contemporary color selection guide.

Luminaire mounting: See technical-mounting options section for more information.

Anti-graffiti and sealer: Optional coatings available for added protection.

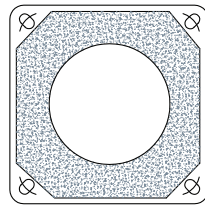

21CT slotted base plate

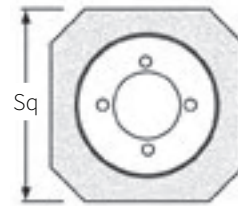

21ST internal bolting

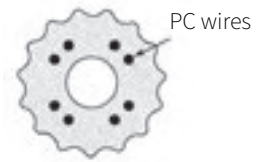

21CT and 21ST shaft cross-section detail

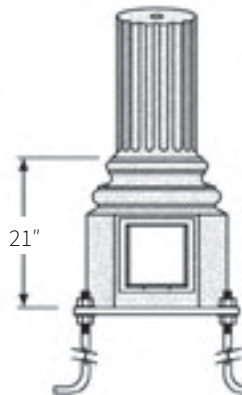

21CT Base plate elevation

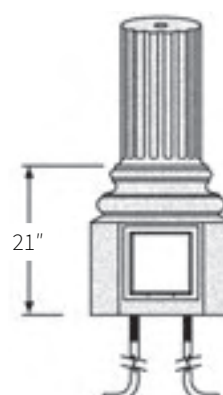

21ST Internal bolting elevation

Ameron

Traditional Series

Corsican Poles

Available in base plate and embedded style

With the delicate leafing and fluted shape, the Corsican pole lends a Mediterranean allure to architectural environments. This timeless design complements both traditional and contemporary settings.

Our Ameron Traditional Series lighting poles combine the charm of yesterday with the technology of today. Available in a wide variety of styles, colors, and finishes, these poles provide architects and designers with many creative options.

Features and Benefits

- Prestressed steel and highest quality concrete are centrifugally cast for ultimate strength and durability
- Natural stone and terrazzo aggregates maintain a like-new appearance with virtually no maintenance
- Conforms to applicable sections of ACI, AASHTO, ASTM, and IBC standards
- Exclusive 10-year warranty

Colors and Finishes

A wide range of standard, preformulated, and custom colors are available. The concrete shafts are lightly blasted to expose the texture and color of the natural stone. See separate aggregates and finishes sheet for details. We offer Amerishield, a premium graffiti-resistant coating, as well as other durable sealers and protectants that further enhance colors, protect the concrete surface, and aid in the removal of graffiti.

Durability with a classic touch



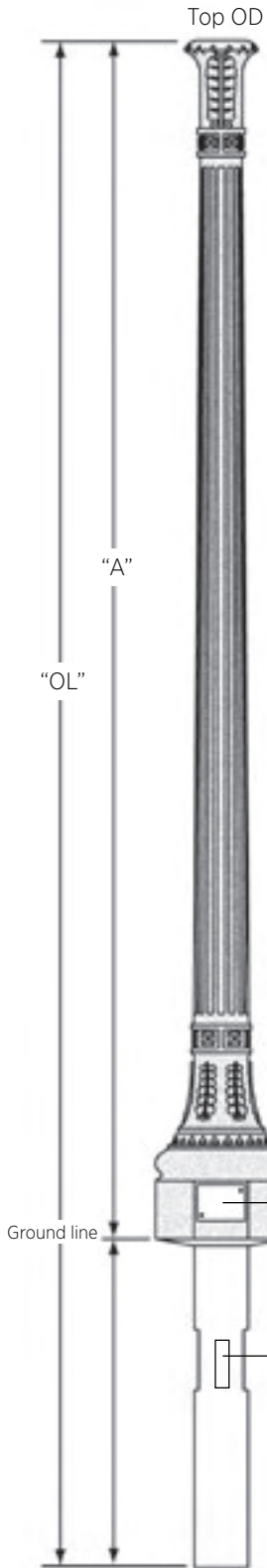

Base plate style - Information

Catalog number	Pole height "A"	Top OD	Base OD	Anchor bolt	Bolt circle	Base plate (Sq)	Ultimate GL moment (ft/lb)	Pole weight (lb)
20CT12	12' 9"	11"	19 1/2"	3/4" x 18" x 4"	22"	20"	21,500	725
20CT15	15' 1"	11"	19 1/2"	3/4" x 18" x 4"	22"	20"	21,500	850

Embedded style - Information

Catalog number	Pole height "A"	Top OD	Base OD	Embedded depth "B"	Overall length "OL"	Ultimate GL moment (ft/lb)	Pole weight (lb)
20ET12	12' 9"	11"	19 1/2"	4' 1"	16' 10"	21,500	900
20ET15	15' 1"	11"	19 1/2"	4' 1"	19' 2"	21,500	1,025

Specifications: Use Contemporary specifications.

Colors and Finishes: See Contemporary color selection guide.

Luminaire Mounting: See technical-mounting options section for more information.

Anti-graffiti and sealer: Optional coatings available for added protection.



Shaft cross-section detail

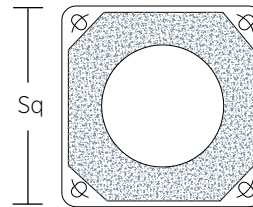

Slotted base plate

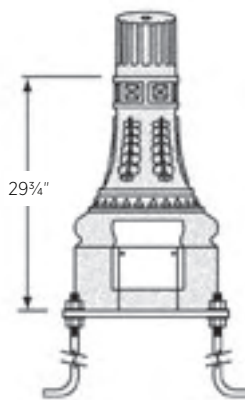

20CT elevation
See recommended "capping detail"

Ameron

Traditional Series

Delphi Poles

Available in base plate and internal bolting

The Delphi pole elegantly enhances surrounding architecture and projects a subtle strength that will withstand the test of time.

Our Ameron Traditional Series lighting poles combine the charm of yesterday with the technology of today. Available in a wide variety of styles, colors, and finishes, these poles provide architects and designers with many creative options.

Features and Benefits

- Prestressed steel and highest quality concrete are centrifugally cast for ultimate strength and durability
- Natural stone and terrazzo aggregates maintain a like-new appearance with virtually no maintenance
- Conforms to applicable sections of ACI, AASHTO, ASTM, and IBC standards
- Exclusive 10-year warranty

Colors and Finishes

A wide range of standard, preformulated, and custom colors are available. The concrete shafts are lightly blasted to expose the texture and color of the natural stone. See separate aggregates and finishes sheet for details. We offer Amerishield, a premium graffiti-resistant coating, as well as other durable sealers and protectants that further enhance colors, protect the concrete surface, and aid in the removal of graffiti.

Durability with a classic touch



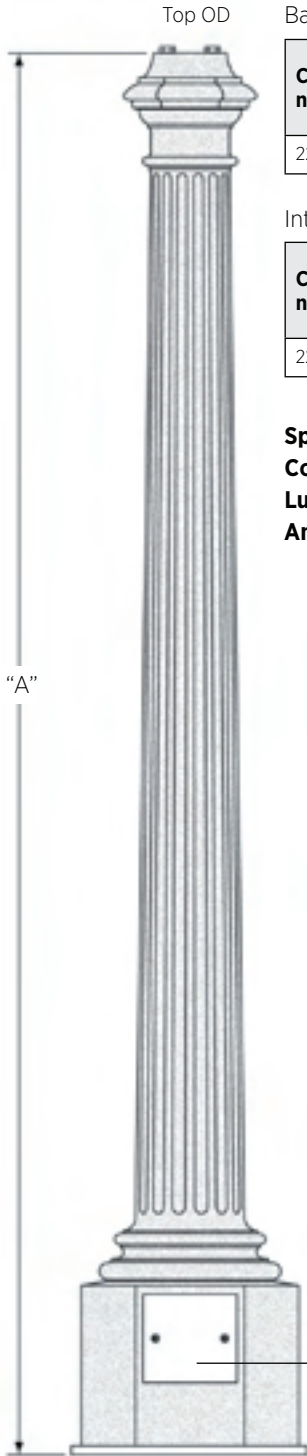

Base plate style - Information

Catalog number	Pole height "A"	Top OD	Base OD	Anchor bolt	Bolt circle	Base plate (Sq)	Ultimate GL moment (ft/lb)	Pole weight (lb)
22CT10	9' 7 1/2"	10"	15 9/16"	3/4" x 18" x 4"	18"	18 1/2"	16,200	540

Internal bolting base plate style - Information

Catalog number	Pole height "A"	Top OD	Base OD	Anchor bolt	Bolt circle	Base plate (Sq)	Ultimate GL moment (ft/lb)	Pole weight (lb)
22ST10	9' 7 1/2"	10"	15 9/16"	1" ø A449	6 1/2"	N/A	16,200	540

Specifications: Use Contemporary specifications.

Colors and Finishes: See Contemporary color selection guide.

Luminaire Mounting: See technical-mounting options section for more information.

Anti-graffiti and sealer: Optional coatings available for added protection.

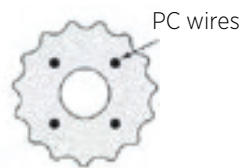

22CT10 and 22ST10 shaft cross-section detail

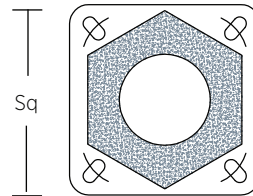

22CT10 slotted base plate



22ST10 internal bolting

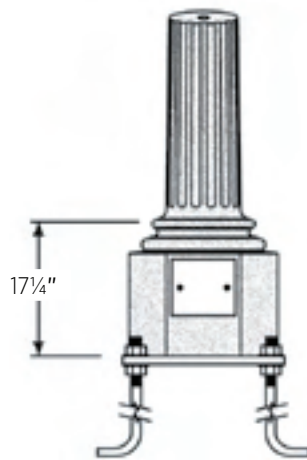

22CT10 elevation
See recommended "capping detail"

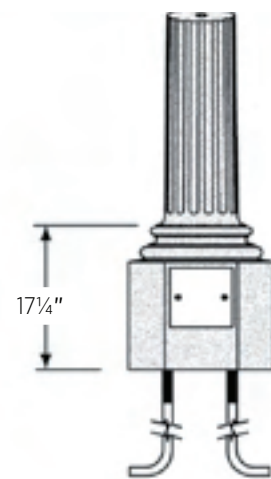

22ST10 elevation

Ameron

Traditional Series

Goleta Poles

Available in base plate style

The curvilinear decorative base with a tapering octagonal shaft creates the perfect streetscape pole to complement a variety of traditional or modern architectural styles.

Our Ameron Traditional Series lighting poles combine the charm of yesterday with the technology of today. Available in a wide variety of styles, colors, and finishes, these poles provide architects and designers with many creative options.

Features and Benefits

- Prestressed steel and highest quality concrete are centrifugally cast for ultimate strength and durability
- Natural stone and terrazzo aggregates maintain a like-new appearance with virtually no maintenance
- Conforms to applicable sections of ACI, AASHTO, ASTM, and IBC standards
- Exclusive 10-year warranty

Colors and Finishes

A wide range of standard, preformulated, and custom colors are available. The concrete shafts are lightly blasted to expose the texture and color of the natural stone. See separate aggregates and finishes sheet for details. We offer Amerishield, a premium graffiti-resistant coating, as well as other durable sealers and protectants that further enhance colors, protect the concrete surface, and aid in the removal of graffiti.

Durability with a classic touch



Top OD
across the flats

Base plate style - Information

Catalog number	Pole height "A"	Top OD	Base OD	Anchor bolt	Bolt circle	Base plate (Sq)	Ultimate GL moment (ft/lb)	Pole weight (lb)
39CT29	29' 3"	6"	8.8"	1" x 36" x 4"	22.5"-25"	21"	30,000	1,800

Specifications: Use Contemporary specifications.

Colors and Finishes: See Contemporary color selection guide.

Luminaire Mounting: See technical-mounting options section for more information.

Anti-graffiti and sealer: Optional coatings available for added protection.

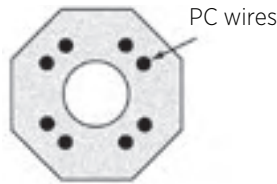
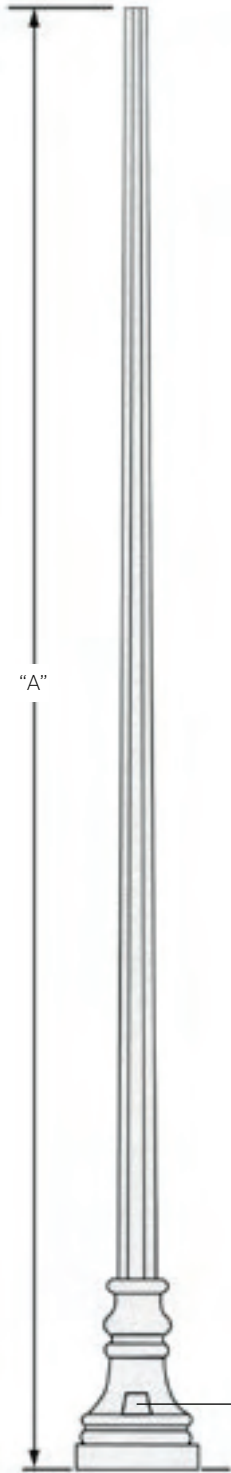

Shaft cross-section detail

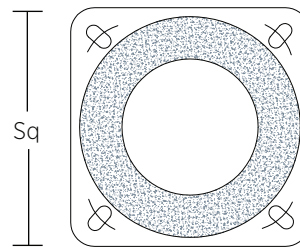

Slotted base plate

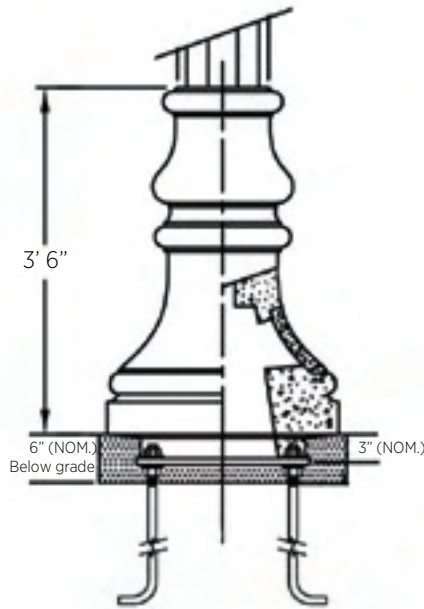

39CT elevation
See recommended
"capping detail"

Ameron

Traditional Series

Huntington Poles

Available in base plate style

The design of the Huntington pole dates back to the 1920s, when similar styles were installed throughout Southern California. When many of the vintage poles were damaged in an earthquake, we were asked to replicate the classic design. Our version features important structural advancements including prestressed steel and centrifugally cast concrete for ultimate strength and long-term structural integrity.

Our Ameron Traditional Series lighting poles combine the charm of yesterday with the technology of today. Available in a wide variety of styles, colors, and finishes, these poles provide architects and designers with many creative options.

Features and Benefits

- Prestressed steel and highest quality concrete are centrifugally cast for ultimate strength and durability
- Natural stone and terrazzo aggregates maintain a like-new appearance with virtually no maintenance
- Conforms to applicable sections of ACI, AASHTO, ASTM, and IBC standards
- Exclusive 10-year warranty

Colors and Finishes

A wide range of standard, preformulated, and custom colors are available. The concrete shafts are lightly blasted to expose the texture and color of the natural stone. See separate aggregates and finishes sheet for details. We offer Amerishield, a premium graffiti-resistant coating, as well as other durable sealers and protectants that further enhance colors, protect the concrete surface, and aid in the removal of graffiti.

Durability with a classic touch



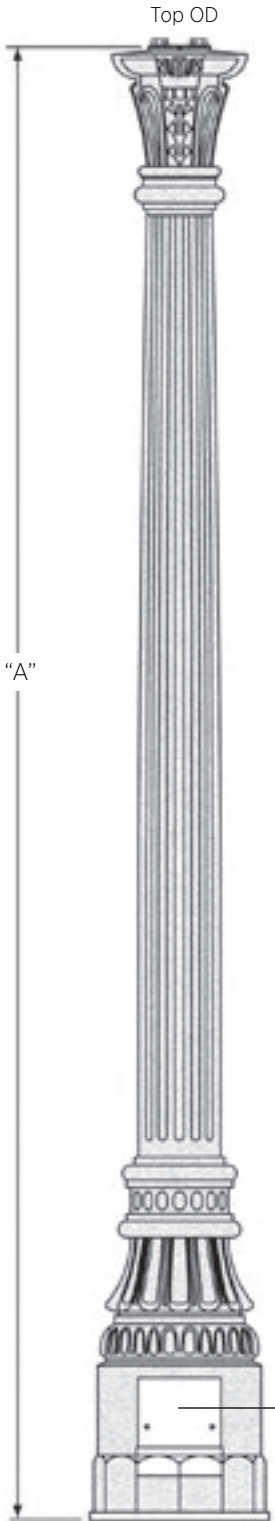

Base plate style - Information

Catalog number	Pole height "A"	Top OD	Base OD	Anchor bolt	Bolt circle	Base plate (Sq)	Ultimate GL moment (ft/lb)	Pole weight (lb)
24CT15	15' 1"	16 ¹ / ₂ "	21"	³ / ₄ " x 18" x 4"	23 ¹ / ₂ "	22 ¹ / ₂ "	20,600	1,100

Specifications: Use Contemporary specifications.

Colors and Finishes: See Contemporary color selection guide.

Luminaire Mounting: See technical-mounting options section for more information.

Anti-graffiti and sealer: Optional coatings available for added protection.



Shaft cross-section detail

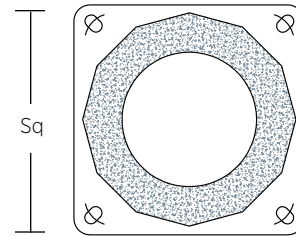

Slotted base plate

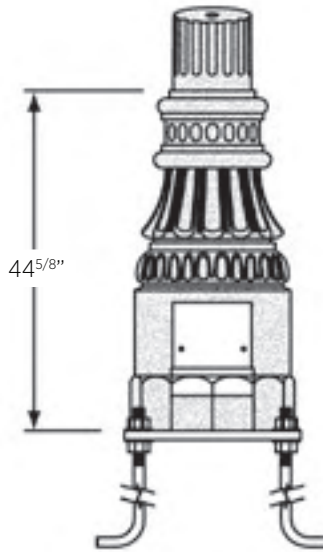

24CT15 elevation
See recommended "capping detail"

Ameron

Traditional Series

Kodiak Poles

Available in base plate and embedded styles

The stark simplicity of the Kodiak pole makes it a fitting complement to a wide variety of architectural styles, both traditional and modern. The tapered octagonal shaft is gracefully understated.

Our Ameron Traditional Series lighting poles combine the charm of yesterday with the technology of today. Available in a wide variety of styles, colors, and finishes, these poles provide architects and designers with many creative options.

Features and Benefits

- Prestressed steel and highest quality concrete are centrifugally cast for ultimate strength and durability
- Natural stone and terrazzo aggregates maintain a like-new appearance with virtually no maintenance
- Conforms to applicable sections of ACI, AASHTO, ASTM, and IBC standards
- Exclusive 10-year warranty

Colors and Finishes

A wide range of standard, preformulated, and custom colors are available. The concrete shafts are lightly blasted to expose the texture and color of the natural stone. See separate aggregates and finishes sheet for details. We offer Amerishield, a premium graffiti-resistant coating, as well as other durable sealers and protectants that further enhance colors, protect the concrete surface, and aid in the removal of graffiti.

Durability with a classic touch



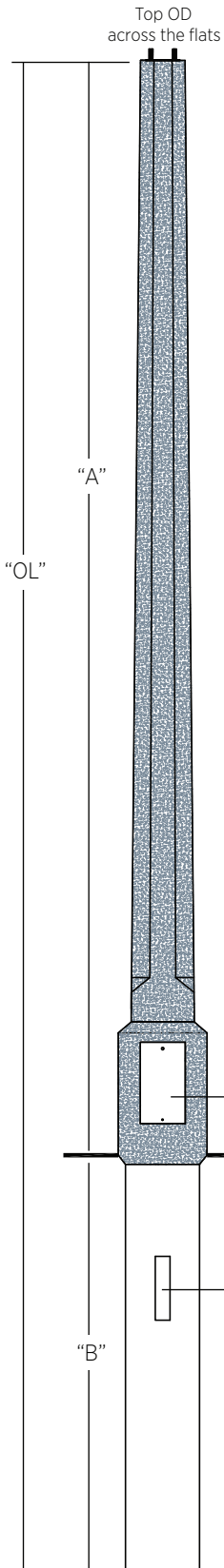

Base plate style - Information

Catalog number	Pole height "A"	Top OD	Base OD	Anchor bolt	Bolt circle	Base plate (Sq)	Ultimate GL moment (ft/lb)	Pole weight (lb)
10CT12	12' 4"	6"	12 ¹ / ₂ "	3/4" x 18" x 4"	7 ¹ / ₂ " x 15"	13 ¹ / ₂ " x 18"	12,500	600
10CT14	14' 4"	5 ¹ / ₂ "	12 ¹ / ₂ "	3/4" x 18" x 4"	7 ¹ / ₂ " x 15"	13 ¹ / ₂ " x 18"	12,500	800
10CT18	18' 4"	4 ¹ / ₂ "	12 ¹ / ₂ "	3/4" x 18" x 4"	7 ¹ / ₂ " x 15"	13 ¹ / ₂ " x 18"	12,500	1,100

Embedded style - Information

Catalog number	Pole height "A"	Top OD	Base OD	Embedded depth "B"	Overall length "OL"	Ultimate GL moment (ft/lb)	Pole weight (lb)
10ET12	12' 4"	6"	12 ¹ / ₂ "	4' 8"	17'	12,500	1,000
10ET14	14' 4"	5 ¹ / ₂ "	12 ¹ / ₂ "	4' 8"	19'	12,500	1,200
10ET18	18' 4"	4 ¹ / ₂ "	12 ¹ / ₂ "	4' 8"	23'	12,500	1,500

Specifications: Use Contemporary specifications.

Colors and Finishes: See Contemporary color selection guide.

Luminaire Mounting: See technical-mounting options section for more information.

Anti-graffiti and sealer: Optional coatings available for added protection.

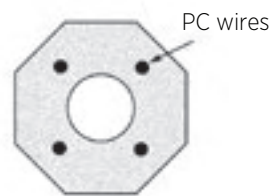

Shaft cross-section detail

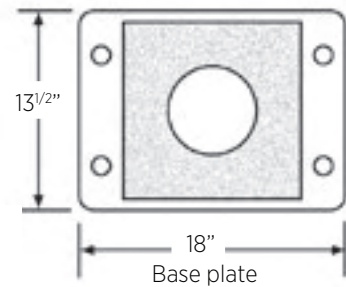

Base plate

Hand hole

Two cable entrances:
1 at 0 degrees
1 at 180 degrees

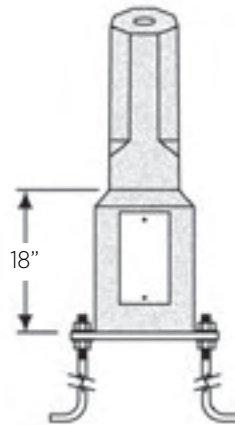

10CT elevation
See recommended "capping details"

Ameron Traditional Series Monterrey Poles

Available in base plate style

The Monterrey pole captures the romance of the Old West. From its stepped buttresses and multiple cornices to the optional unique bell-shaped luminaries, this pole represents an artistic blending of designs from Spain, Mexico and the American West.

This timeless design complements both traditional and contemporary settings. Our Ameron Traditional Series lighting poles combine the charm of yesterday with the technology of today. Available in a wide variety of styles, colors, and finishes, these poles provide architects and designers with many creative options.

Features and Benefits

- Prestressed steel and highest quality concrete are centrifugally cast for ultimate strength and durability
- Natural stone and terrazzo aggregates maintain a like-new appearance with virtually no maintenance
- Conforms to applicable sections of ACI, AASHTO, ASTM, and IBC standards
- Exclusive 10-year warranty

Colors and Finishes

A wide range of standard, preformulated, and custom colors are available. The concrete shafts are lightly blasted to expose the texture and color of the natural stone. See separate aggregates and finishes sheet for details. We offer Amerishield, a premium graffiti-resistant coating, as well as other durable sealers and protectants that further enhance colors, protect the concrete surface, and aid in the removal of graffiti.

Durability with a classic touch



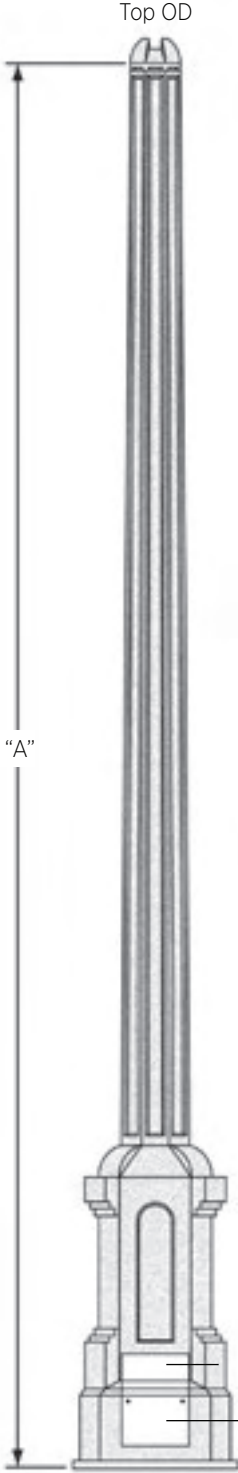

Base plate style - Information

Catalog number	Pole height "A"	Top OD	Base OD	Anchor bolt	Bolt circle	Base plate (Sq)	Ultimate GL moment (ft/lb)	Pole weight (lb)
9CT14	13' 10"	9"	24"	3/4" 18" x 4"	31 1/2"	24"	26,800	1,850
9CT17	17' 6"	8.5"	24"	3/4" 18" x 4"	31 1/2"	24"	26,800	2,125

Specifications: Use Contemporary specifications.
Colors and Finishes: See Contemporary color selection guide.
Luminaire Mounting: See technical-mounting options section for more information.
Anti-graffiti and sealer: Optional coatings available for added protection.

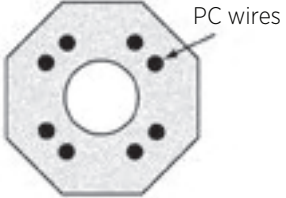

9CT shaft cross-section detail

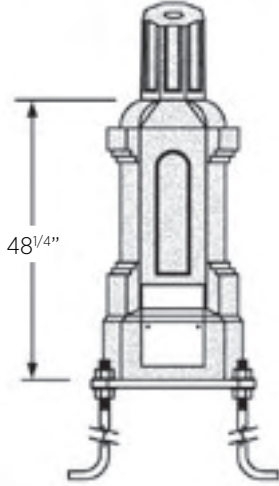

Elevation
See recommended "capping detail"

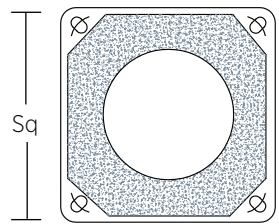

Ameron

Traditional Series

Olympian Poles

Available in base plate and internal bolting

Strong and massive, the Olympian pole makes a bold architectural statement whether it appears in traditional or more modern surroundings. Superb detailing recalls the enduring beauty of Greco-Roman designs.

Our Ameron Traditional Series lighting poles combine the charm of yesterday with the technology of today. Available in a wide variety of styles, colors, and finishes, these poles provide architects and designers with many creative options.

Features and Benefits

- Prestressed steel and highest quality concrete are centrifugally cast for ultimate strength and durability
- Natural stone and terrazzo aggregates maintain a like-new appearance with virtually no maintenance
- Conforms to applicable sections of ACI, AASHTO, ASTM, and IBC standards
- Exclusive 10-year warranty

Colors and Finishes

A wide range of standard, preformulated, and custom colors are available. The concrete shafts are lightly blasted to expose the texture and color of the natural stone. See separate aggregates and finishes sheet for details. We offer Amerishield, a premium graffiti-resistant coating, as well as other durable sealers and protectants that further enhance colors, protect the concrete surface, and aid in the removal of graffiti.

Durability with a classic touch



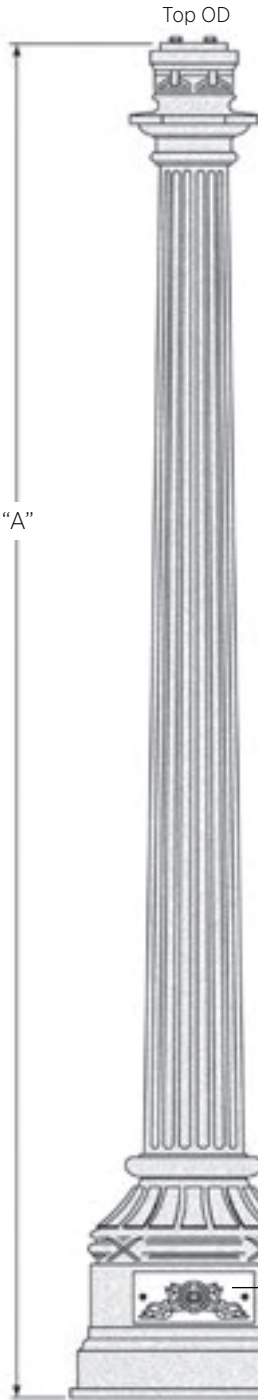

Base plate style - Information

Catalog number	Pole height "A"	Top OD	Base OD	Anchor bolt	Bolt circle	Base plate (Sq)	Ultimate GL moment (ft.lb)	Pole weight (lb)
23CT11	10' 9"	7"	22"	3/4" x 18" x 4"	24 3/8"	22 1/2"	17,500	950

Internal bolting base plate style - Information

Catalog number	Pole height "A"	Top OD	Base OD	Anchor bolt	Bolt circle	Base plate (Sq)	Ultimate GL moment (ft.lb)	Pole weight (lb)
23ST11	10' 9"	7"	22"	1" ø A449	7"	N/A	17,500	950

Specifications: Use Contemporary specifications.
Colors and Finishes: See Fillmore color selection guide.
Luminaire Mounting: See technical-mounting options section for more information.
Anti-graffiti and sealer: Optional coatings available for added protection.



Shaft cross-section detail

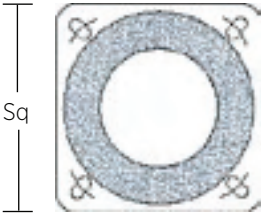

23CT11 slotted base plate



23ST11 internal bolting

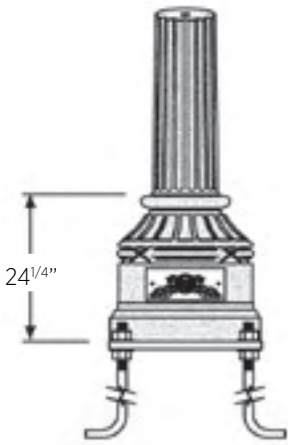

Elevation
See recommended "capping detail"

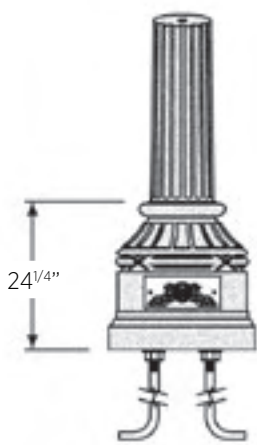

Elevation
See recommended "capping detail"

Ameron

Traditional Series

Washington Poles

Available in base plate style

In 1910 the Commission of Fine Arts in Washington D.C. designed the simple, classically fluted lighting standard on which the Ameron Washington pole is based. Our version of the classic design is available in durable, low-maintenance, prestressed, and spun-cast concrete that retains its beauty for many years even in the most severe weather conditions.

This timeless design complements both traditional and contemporary settings. Our Ameron Traditional Series lighting poles combine the charm of yesterday with the technology of today. Available in a wide variety of styles, colors, and finishes, these poles provide architects and designers with many creative options.

Features and Benefits

- Prestressed steel and highest quality concrete are centrifugally cast for ultimate strength and durability
- Natural stone and terrazzo aggregates maintain a like-new appearance with virtually no maintenance
- Conforms to applicable sections of ACI, AASHTO, ASTM, and IBC standards
- Exclusive 10-year warranty

Colors and Finishes

A wide range of standard, pre-formulated and custom colors are available. The concrete shafts are lightly blasted to expose the texture and color of the natural stone. See separate Aggregates and Finishes sheet for details. We offer Amerishield a premium graffiti-resistant coating, as well as other durable sealers and protectants that further enhance colors, protect the concrete surface, and aid in the removal of graffiti.

Durability with a classic touch



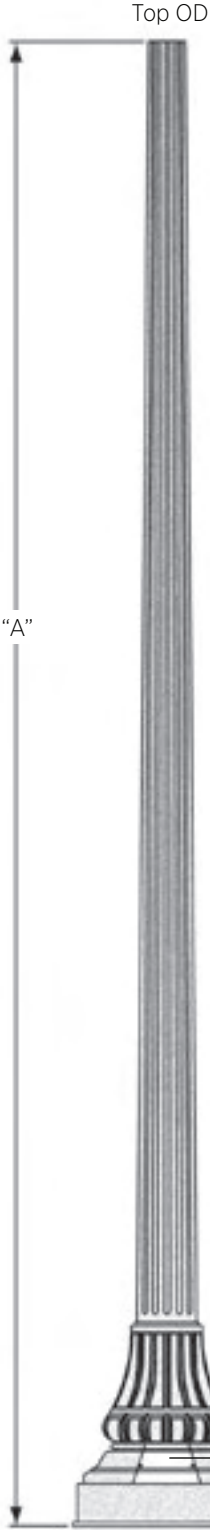

Base plate style - Information

Catalog number	Pole height "A"	Top OD	Base OD	Anchor bolt	Bolt circle	Base plate (Sq)	Ultimate GL moment	Pole weight (lb)
26CT10	9' 6"	5 ³ / ₈ "	21"	3/4" x 18"x4"	24"	22 ¹ / ₂ "	12,000	450
26CT12	12'	5 ³ / ₄ "	21"	3/4" x 18"x4"	24"	22 ¹ / ₂ "	12,000	480
26CT14	14' 6"	5 ¹ / ₄ "	21"	3/4" x 18"x4"	24"	22 ¹ / ₂ "	12,000	510

Specifications: Use Contemporary specifications.
Colors and Finishes: See Contemporary color selection guide.
Luminaire Mounting: See technical-mounting options section for more information.
Anti-graffiti and sealer: Optional coatings available for added protection.

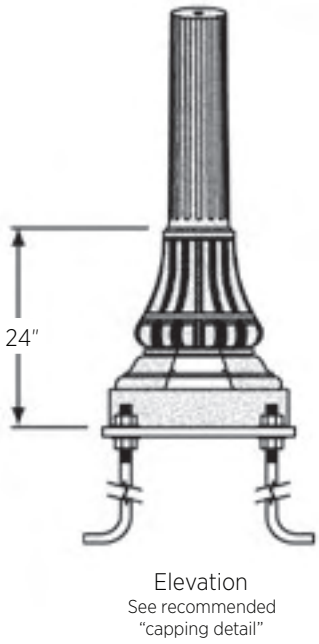
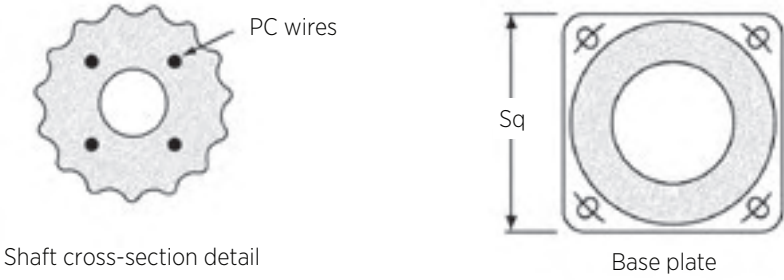

Ameron Washington Poles - Embedded

Available in Centrecon and Contemporary series

In 1910 the Commission of Fine Arts in Washington D.C. designed the simple, classically fluted lighting standard on which the Ameron Washington pole is based. Our version of the classic design is available in durable, low-maintenance, prestressed, and spun-cast concrete that retains its beauty for many years even in the most severe weather conditions.

Features and Benefits

- Prestressed steel and highest quality concrete are centrifugally cast for ultimate strength and durability
- Natural stone and terrazzo aggregates maintain a like-new appearance with virtually no maintenance
- Conforms to applicable sections of ACI, AASHTO, ASTM, and IBC standards
- Exclusive 10-year warranty

Colors and Finishes

A wide range of standard, preformulated, and custom colors are available. The concrete shafts are lightly blasted to expose the texture and color of the natural stone. See separate aggregates and finishes sheet for details. We offer Amerishield, a premium graffiti-resistant coating, as well as other durable sealers and protectants that further enhance colors, protect the concrete surface, and aid in the removal of graffiti.

Durability with a classic touch



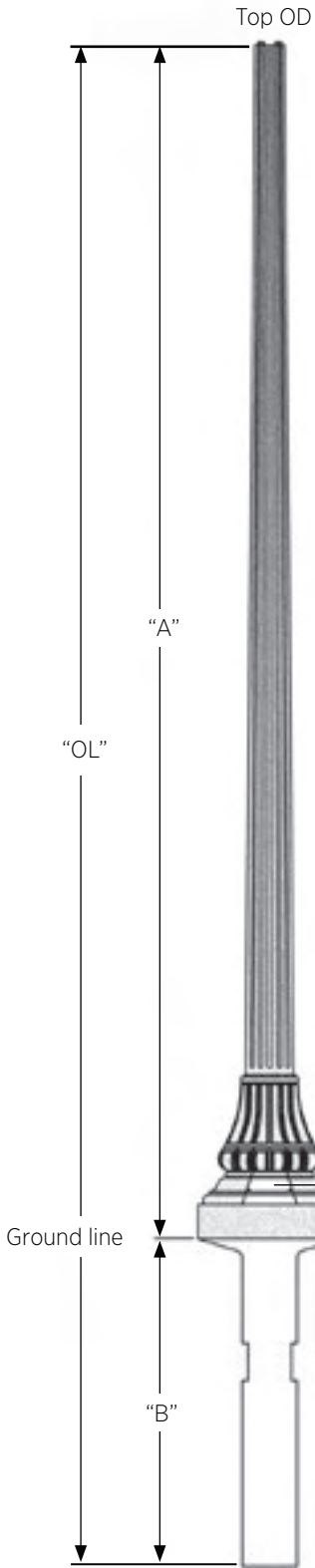

Embedded style - Information

Catalog number	Pole height "A"	Top OD	Base OD	Embedded depth "B"	Overall length "OL"	Ultimate GL moment (ft/lb)	Pole weight (lb)
26ET10	9' 6"	5 ³ / ₈ "	21"	4'	13' 6"	12,000	710
26ET12	12'	4 ³ / ₄ "	21"	4'	16'	12,000	740
26ET14	14' 6"	4 ¹ / ₄ "	21"	4'	18' 6"	12,000	770

Specifications: Use Contemporary specifications.

Colors and Finishes: See Contemporary color selection guide.

Luminaire Mounting: See technical-mounting options section for more information.

Anti-graffiti and sealer: Optional coatings available for added protection.

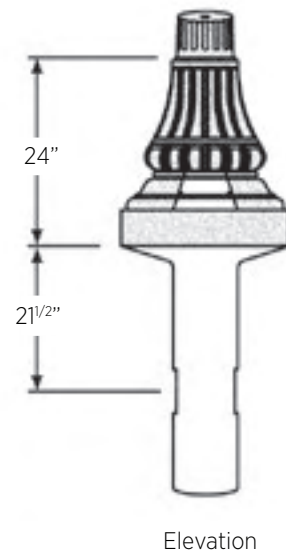
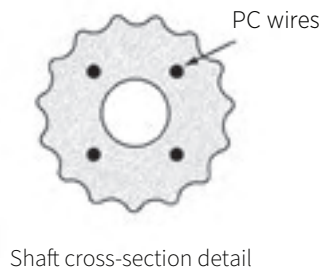

Ameron Tall Washington Poles

Available in base plate and embedded styles

In 1910 the Commission of Fine Arts in Washington D.C. designed the classically fluted lighting standard on which our Washington pole is based. Our Tall Washington is made from prestressed spun-cast concrete and will retain its beauty for many years, even in severe weather conditions.

Features and Benefits

- Prestressed steel and highest quality concrete are centrifugally cast for ultimate strength and durability
- Natural stone and terrazzo aggregates maintain a like-new appearance with virtually no maintenance
- Conforms to applicable sections of ACI, AASHTO, ASTM, and IBC standards
- Exclusive 10-year warranty

Colors and Finishes

A wide range of standard, preformulated, and custom colors are available. The concrete shafts are lightly blasted to expose the texture and color of the natural stone. See separate aggregates and finishes sheet for details. We offer Amerishield, a premium graffiti-resistant coating, as well as other durable sealers and protectants that further enhance colors, protect the concrete surface, and aid in the removal of graffiti.

Durability with a classic touch



Base plate style - Information

Catalog number	Pole height "A"	Base OD	Anchor bolt	Bolt circle	Base plate (Sq)	Ultimate GL moment (ft/lb)	Pole weight (lb)
VBWX07.5	24' 7"	24"	1" x 36" x 6"	20"-21"	18"	24,300	1,300
VBWX09.0	29' 6"	24"	1" x 36" x 6"	20"-21"	18"	28,200	1,400

Embedded style - Information

Catalog number	Pole height "A"	Base OD	Embedded depth "B"	Overall length "OL"	Ultimate GL moment (ft/lb)	Pole weight (lb)
VEWX07.5	24' 7"	24"	4' 11"	29' 6"	24,300	1,800
VEWX09.0	29' 6"	24"	4' 11"	34' 5"	28,200	1,900

- Specifications:** Use Contemporary specifications.
- Colors and Finishes:** See Contemporary color selection guide.
- Luminaire Mounting:** See technical-mounting options section for more information.
- Anti-graffiti and sealer:** Optional coatings available for added protection.

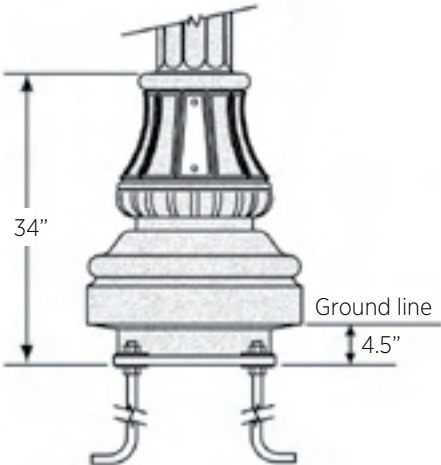
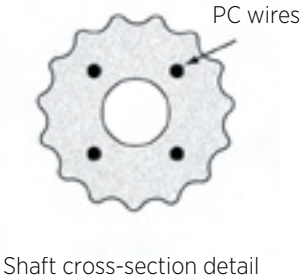
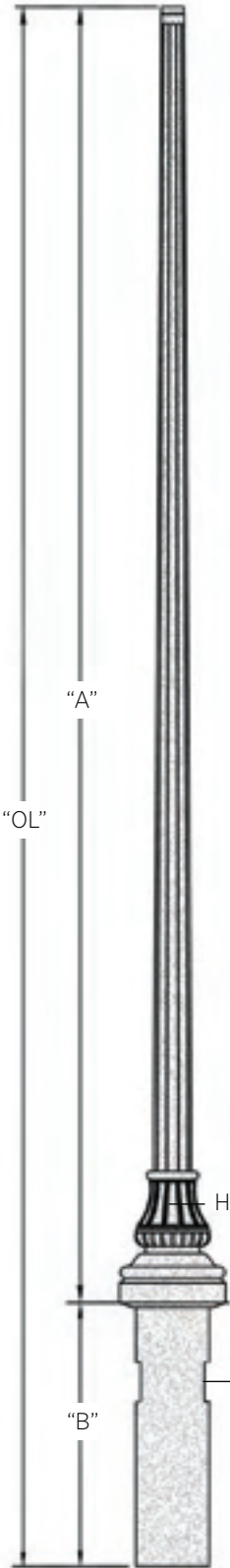

Elevation
See recommended "capping detail"

We're ready to **partner**
with you to provide the
right solution for your
environment.





